

Agilent E5052B Signal Source Analyzer

Installation Guide

First Edition



Manufacturing No. E5052-90006

May 2007

Notices

The information contained in this document is subject to change without notice.

This document contains proprietary information that is protected by copyright. All rights are reserved. No part of this document may be photocopied, reproduced, or translated to another language without the prior written consent of Agilent Technologies.

Microsoft®, MS-DOS®, Windows®, Visual C++®, Visual Basic®, VBA® and Excel® are registered trademarks of Microsoft Corporation.

Java® is registered trademark of Sun Microsystems Corporation.

© Copyright 2007 Agilent Technologies

Manual Printing History

The manual's printing date and part number indicate its current edition. The printing date changes when a new edition is printed (minor corrections and updates that are incorporated at reprint do not cause the date to change). The manual part number changes when extensive technical changes are incorporated.

May 2007 First Edition

Safety Summary

The following general safety precautions must be observed during all phases of operation, service, and repair of this instrument. Failure to comply with these precautions or with specific WARNINGS elsewhere in this manual may impair the protection provided by the equipment. Such noncompliance would also violate safety standards of design, manufacture, and intended use of the instrument. Agilent Technologies assumes no liability for the customer's failure to comply with these precautions.

NOTE

The E5052B complies with INSTALLATION CATEGORY II as well as POLLUTION DEGREE 2 in IEC61010-1. The E5052B is an INDOOR USE product.

NOTE

The LEDs in the E5052B are Class 1 in accordance with IEC60825-1, CLASS 1 LED PRODUCT









- Ground the Instrument
To avoid electric shock, the instrument chassis and cabinet must be grounded with the supplied power cable's grounding prong.
- DO NOT Operate in an Explosive Atmosphere
Do not operate the instrument in the presence of inflammable gasses or fumes. Operation of any electrical instrument in such an environment clearly constitutes a safety hazard.
- Keep Away from Live Circuits
Operators must not remove instrument covers. Component replacement and internal adjustments must be made by qualified maintenance personnel. Do not replace components with the power cable connected. Under certain conditions, dangerous voltage levels may remain even after the power cable has been disconnected. To avoid injuries, always disconnect the power and discharge circuits before touching them.
- DO NOT Service or Adjust the Instrument Alone
Do not attempt internal service or adjustment unless another person, capable of rendering first aid and resuscitation, is present.
- DO NOT Substitute Parts or Modify the Instrument
To avoid the danger of introducing additional hazards, do not install substitute parts or perform unauthorized modifications to the instrument. Return the instrument to an Agilent Technologies Sales and Service Office for service and repair to ensure that safety features are maintained in operational condition.
- Dangerous Procedure Warnings
Warnings, such as the example below, precede potentially dangerous procedures throughout this manual. Instructions contained in the warnings must be followed.

WARNING

Dangerous voltage levels, capable of causing death, are present in this instrument. Use extreme caution when handling, testing, and adjusting this instrument.

Safety Symbols

General definitions of safety symbols used on the instrument or in manuals are listed below.

-  Instruction Manual symbol: the product is marked with this symbol when it is necessary for the user to refer to the instrument manual.
-  Alternating current.
-  Direct current.
-  On (Supply).
-  Off (Supply).
-  In-position of push-button switch.
-  Out-position of push-button switch.
-  A chassis terminal; a connection to the instrument's chassis, which includes all exposed metal structure.
-  Stand-by.

WARNING This warning sign denotes a hazard. It calls attention to a procedure, practice, or condition that, if not correctly performed or adhered to, could result in injury or death to personnel.

CAUTION This CAUTION sign denotes a hazard. It calls attention to a procedure, practice, or condition that, if not correctly performed or adhered to, could result in damage to or destruction of part or all of the instrument.

NOTE This NOTE sign denotes important information. It calls attention to a procedure, practice, or condition that is essential for the user to understand.

Certification

Agilent Technologies certifies that this product met its published specifications at the time of shipment from the factory. Agilent Technologies further certifies that its calibration measurements are traceable to the United States National Institute of Standards and Technology, to the extent allowed by the Institution's calibration facility or by the calibration facilities of other International Standards Organization members.

Documentation Warranty

The material contained in this document is provided "as is," and is subject to being changed, without notice, in future editions. Further, to the maximum extent permitted by applicable law, Agilent disclaims all warranties, either express or implied with regard to this manual and any information contained herein, including but not limited to the implied warranties of merchantability and fitness for a particular purpose. Agilent shall not be liable for errors or for incidental or consequential damages in connection with the furnishing, use, or performance of this document or any information contained herein. Should Agilent and the user have a separate written agreement with warranty terms covering the material in this document that conflict with these terms, the warranty terms in the separate agreement will control.

Exclusive Remedies

The remedies provided herein are Buyer's sole and exclusive remedies. Agilent Technologies shall not be liable for any direct, indirect, special, incidental, or consequential damages, whether based on contract, tort, or any other legal theory.

Assistance

Product maintenance agreements and other customer assistance agreements are available for Agilent Technologies products.

For any assistance, contact your nearest Agilent Technologies Sales and Service Office. Addresses are provided at the back of this manual.

Typeface Conventions

Sample (bold)

Boldface type is used when a term is defined or emphasized.

Sample (Italic)

Italic type is used for emphasis and for titles of manuals and other publications.

Sample menu/button/box/tab

Indicates a menu/button/box/tab on the screen labeled “Sample” which can be selected/executed by clicking. “menu”, “button”, “box”, or “tab” may be omitted.

[Sample]

Indicates the hardkey whose key label is “Sample”.

[Sample] > Item

Indicates a series of key operations in which you press the **[Sample]** key, make the item called “Item” on the displayed menu blink by using the **[↓]** or in other ways, and then press the **[Enter]** key.

1. Introduction	
Manuals for E5052B	10
Contents of This Manual	10
2. Installation	
Checking the Shipment	13
Environmental Requirements	14
Operating Environments	14
Ventilation Requirements	15
Protection Against Electrostatic Discharge (ESD)	16
Ensuring Adequate Free Space around Analyzer for Immediate Disconnection of Power Cable in Case of Emergency	16
Installing Front Handles/Rack Mounting Flanges	17
How to Install the Handle Kit (Option 1CN)	18
How to Install the Rack-mount Kit (Option 1CM)	19
How to Install the Rack-mount and Handle Kit (Option 1CP)	19
Connecting the Accessories	20
Connecting Mouse and Keyboard	20
Power Supply	21
Verification of the Power Supply	21
Verification and Connection of Power Cable	21
Blown fuses	23
Starting the E5052B	24
Turning the Power ON and OFF	24
Disconnection from Supply Source	25
Removing / Mounting Removable Hard Disk	26
Initial Registration of E5052B	27
Calibration of the Touch Screen	29
3. Troubleshooting	
Troubleshooting during Startup	32
System Recovery	33
Types of system recoveries	33
Notes on executing the factory recovery function	33
Procedure to execute the factory recovery	34
Procedure to create the user backup image	37
Procedure to execute the user recovery function	43

1 Introduction

This chapter introduces the documentation for Agilent E5052B and the overview of this manual to use this manual efficiently. See this manual first when you use the E5052B for the first time.

Manuals for E5052B

Agilent provides the following three manuals for E5052B. The latest version of all documentations can be downloaded from <http://www.agilent.com/find/ssa/>.

Installation Guide

The installation guide (this manual) provides start up setup information when you use the E5052B for the first time and troubleshooting information when the Windows cannot be boot up.

Online Help

The online help provides the information about the measurement operation, programming, built-in VBA, I/O interface. This is pre-installed in the E5052B. Press [Help] hard key on the front panel to open.

Service Guide

The service manual provides information about the parts, troubleshooting, performance test, adjustment and service menu.

Contents of This Manual

The following shows the contents of this manual.

Chapter 1, “Introduction”

This chapter introduces the documentation for Agilent E5052B and the overview of this manual to use this manual efficiently. See this manual first when you use the E5052B for the first time.

Chapter 2, “Installation”

This chapter provides information about how to set up the Agilent E5052B.

Chapter 3, “Troubleshooting”

This chapter describes the troubleshooting during start up and the procedure of the operating system (OS) recovery when the Windows XP OS has been damaged.

2 Installation

This chapter provides information about how to set up the Agilent E5052B.

Contents of this Chapter

- ❑ **Checking the Shipment on page 13**

After you receive the analyzer, check all the items in the packing container.
- ❑ **Environmental Requirements on page 14**

Describes the system requirements needed to install the E5052B and how to secure space for heat radiation.
- ❑ **Installing Front Handles/Rack Mounting Flanges on page 17**

Shows how to mount the front handles used to transport the E5052B and how to install the flanges needed to install it in a rack.
- ❑ **Connecting the Accessories on page 20**

Provides information for connecting the mouse, keyboard, BNC adaptor to the E5052B.
- ❑ **Power Supply on page 21**

Shows how to check the power supply as well as check and connect the power cable.
- ❑ **Starting the E5052B on page 24**

Describes turning on/off of the Power switch and cutting off the power supply.
- ❑ **Initial Registration of E5052B on page 27**

Provides the procedure of initial registration for the Windows XP operating system of the E5052B.
- ❑ **Calibration of the Touch Screen on page 29**

Provides the procedure of touch screen calibration.

Checking the Shipment

After you receive the analyzer, carry out checks during unpacking according to the following procedure.

WARNING

When unpacking the analyzer, if the external face of the analyzer (such as the cover, front/rear panel, LCD screen, power switch, and port connectors) appear to be damaged during transport, do not turn on the power switch. Otherwise, you may get an electric shock.

-
- Step 1.** Check that the packing box or shock-absorbing material used to package the analyzer has not been damaged.

NOTE

If the packing box or shock-absorbing material has been damaged, leave the packing box and shock-absorbing material as is until other inspection items are checked as follows:

- Step 2.** Check the packaged items supplied with the analyzer for any damage or defects.
- Step 3.** By referring to the furnished contents list, check that all packaged items supplied with the analyzer have been provided as per the specified options.
- Step 4.** After checking, if one of the following applies, contact your nearest Agilent Technologies sales and service office.
1. The packing box or shock-absorbing material used to package the analyzer has been damaged or the shock-absorbing material has traces where extreme force has been applied.
 2. A packaged item supplied with the analyzer has mechanical damage or defects.
 3. A packaged item supplied with the analyzer is missing.
 4. A fault has been detected in the subsequent operation check of the analyzer.

If an abnormality is detected in step 1, contact the company that transported the analyzer as well as your nearest Agilent Technologies sales and service office. For inspection by the transport company, save the packing box, shock-absorbing material, and packaged items as you received them.

Environmental Requirements

Set up the E5052B where the following environmental requirements are met.

Operating Environments

Ensure that the operating environment meets the following requirements.

Temperature	10 °C to 40 °C
Temperature range at the error-correction	23 °C ± 5 °C (< 1 °C deviation from the temperature when performing the error-correction)
Humidity	20% to 80% at wet bulb temperature < +29 °C (non-condensation)
Altitude	0 to 2,000 m (0 to 6,561 feet)
Vibration	0.21 G maximum, 5 Hz to 500 Hz

NOTE

Above environmental requirements are NOT for the specifications and measurement accuracy of the analyzer, but for the operating environment of the analyzer.

Ventilation Requirements

To ensure safety requirements, the specifications and measurement accuracy of the analyzer, you must keep environmental temperature within the specified range by providing appropriate cooling clearance around the analyzer or, for the rackmount type, by forcefully air-cooling inside the rack housing. For more information on environmental temperature to satisfy the specifications and measurement accuracy of the analyzer, see the specification in the *E5052B Online Help*.

When the environmental temperature around the analyzer is kept within the temperature range of the operating environment specification (See Section “Operating Environments” on page 14), the analyzer conforms to the requirements of the safety standard. Furthermore, under that temperature requirement, the analyzer still conforms to the requirements of the safety standard even when placing the analyzer with cooling clearance as follows:

	Requirements
Back	≥ 180 mm
Sides	≥ 60 mm (both right and left)

Figure 2-1

Ventilation space at the installation

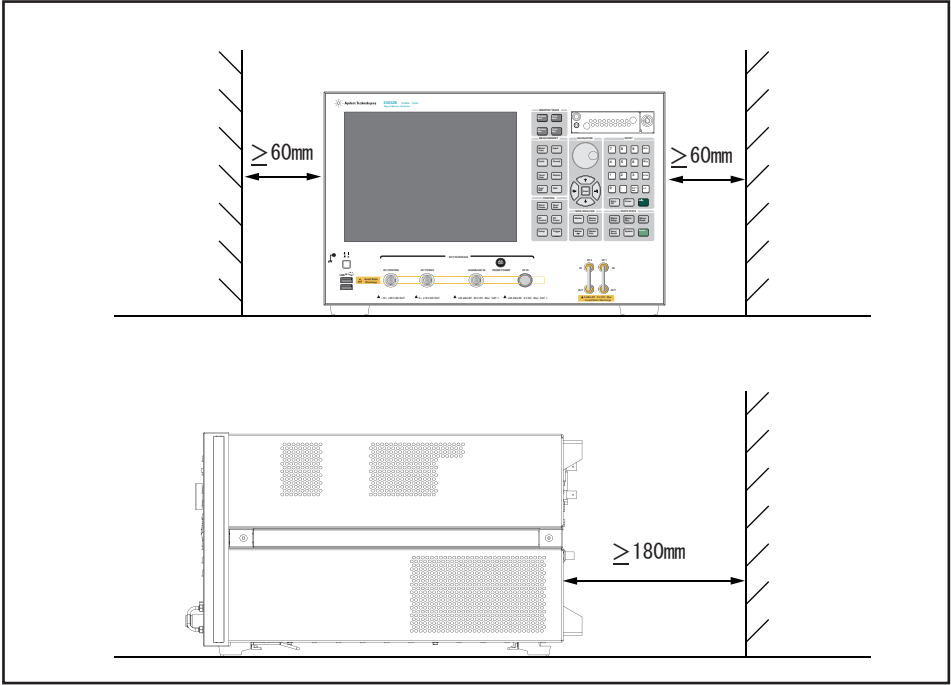

e5052bqe1001

NOTE When measuring place the E5052B in a proper position as show in Figure 2-1.

Protection Against Electrostatic Discharge (ESD)

Set up a static-safe work-station to protect the electronic components from the damage by the electrostatic discharge (ESD) as shown in Figure 2-2. Table 2-1 shows the accessories available that provide ESD protection.

Table 2-1 The accessories available that provide ESD protection

Name	Agilent Part Number
Static-control table mat and earth ground wire	9300-0797
Wrist-strap cord	9300-0980
Wrist-strap	9300-1383
Heel-straps	9300-1169

Figure 2-2 Example of the static-safe work-station

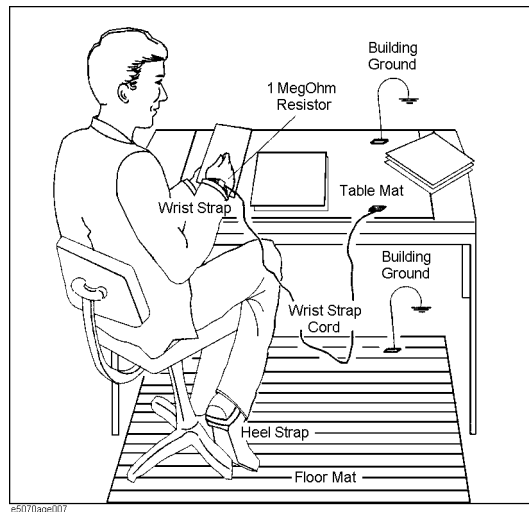

Ensuring Adequate Free Space around Analyzer for Immediate Disconnection of Power Cable in Case of Emergency

As described in “Disconnection from Supply Source” on page 25, the power supply is disconnected by removing the power cable’s connector plug from either the AC outlet or the E5052B unit. When installing the E5052B, ensure that there is sufficient free space around the unit to permit quick disconnection of the plug (from AC outlet or E5052B unit) in case of emergency.

Installing Front Handles/Rack Mounting Flanges

The E5052B can be installed on a workbench or in a rack. This section describes how to install the front handles (Option 1CN) used for moving or transporting the instrument, and how to install the analyzer in an equipment rack as part of a measurement system (Option 1CM: without the handles, Option 1CP: with the handles).

Table 2-2

Agilent E5052B handles/rack mounting options

Option	Name	Agilent Part Number
1CN	Handle Kit	5063-9230
1CM	Rack-mount Kit	5063-9217
1CP	Rack-mount and Handle Kit	5063-9224

Table 2-3

Contents of each option

Option	Contents	Quantity
1CN	Front Handles	2
	Screws	6
	Trim Strips	2
1CM	Rack-mounting flanges (locking side plate)	2
	Screws	6
1CP	Rack-mounting flanges (locking side plate)	2
	Front Handles	2
	Screws	8

Figure 2-3 Installing front handle/rack-mount kits

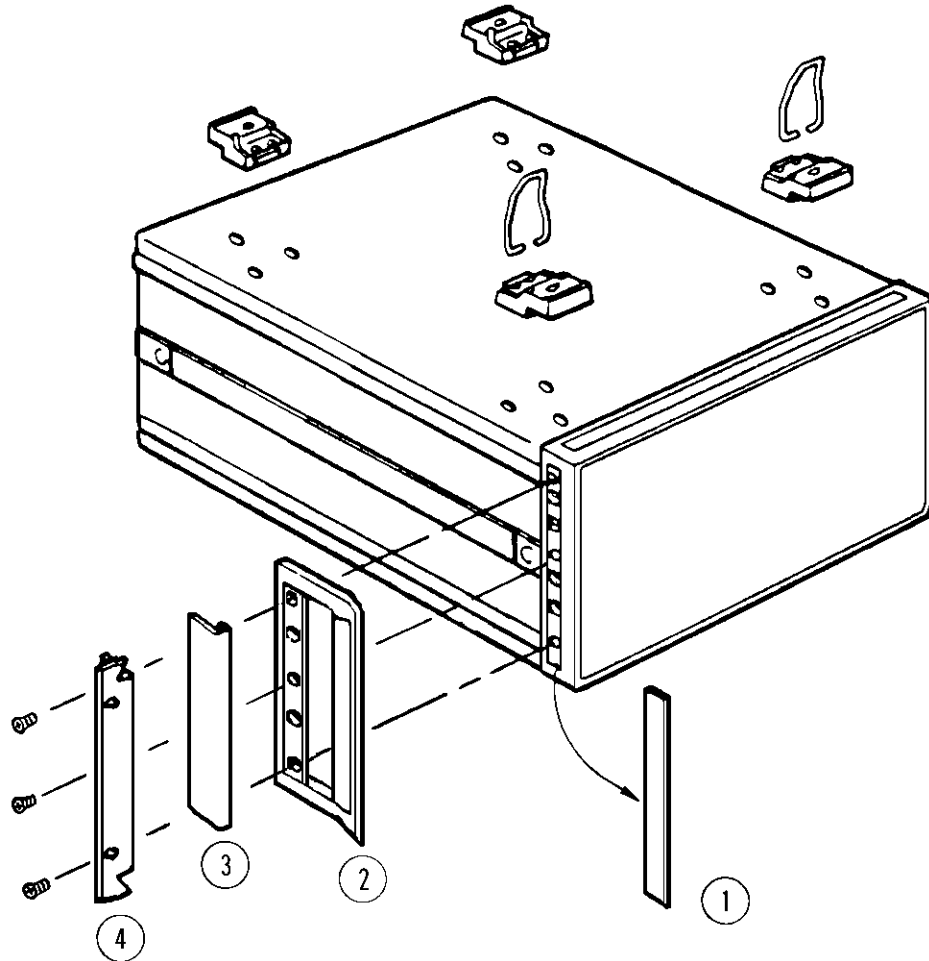

e5070aqj009

How to Install the Handle Kit (Option 1CN)

The handle kit is used for transport and relocation of the E5052B. While referring to Figure 2-3, install the handle kit by following these steps.

- Step 1.** Remove the adhesive-backed trim strip (1) from each side of the outer frame of the E5052B front panel.
- Step 2.** Use the provided screws to mount the front handles (2) on each side of the E5052B front panel frame.
- Step 3.** Attach the provided modified trim strip (3) to each front handle in order to cover the front panel locking screws.

WARNING

If the installed front handle becomes damaged, replace it with a new one immediately. A damaged handle can break while moving or lifting the instrument and cause personal injury or damage to the instrument.

How to Install the Rack-mount Kit (Option 1CM)

The rack-mount kit includes two flanges (locking side plates) for mounting the E5052B on a rack (482.6 mm/19 inches) conforming to the EIA Standard. While referring to Figure 2-3, install the rack-mount kit by following these steps.

- Step 1.** Remove the adhesive-backed trim strip (1) from each side of the outer frame of the E5052B front panel.
- Step 2.** Use the provided screws to mount a rack-mounting flange (4) on each side of the E5052B front panel frame.
- Step 3.** Remove the four bottom feet of the E5052B (lift the bar marked TAB on the inner side of the foot and slide the foot toward the bar).
- Step 4.** Mount the E5052B on the rack.

How to Install the Rack-mount and Handle Kit (Option 1CP)

The rack-mount and handle kit includes both the rack-mounting flanges (locking side plates) and front handles. While referring to Figure 2-3, install the rack-mount kit by following these steps.

- Step 1.** Remove the adhesive-backed trim strip (1) from each side of the outer frame of the E5052B front panel.
- Step 2.** Use the provided screws to mount a front handle (2) and rack-mounting flange (4) on each side of the E5052B front panel frame.

CAUTION

Use both a front handle and a rack-mounting flange in the same time certainly. Do not attempt to install flanges or handles separately with hardware provided. Serious electrical damage will occur to the instrument.

- Step 3.** Remove the four bottom feet of the E5052B (lift the bar marked TAB on the inner side of the foot and slide the foot toward the bar).
- Step 4.** Mount the E5052B on the rack.

Connecting the Accessories

You need to connect some accessories before use.

Connecting Mouse and Keyboard

E5052B allows you to connect Mouse and/or keyboard through USB or PS/2. USB mouse and keyboard can be connected with the USB ports on the front or rear panels.

Initial registration of the E5052B requires the mouse and the keyboard before turning on the power.

Power Supply

Before turning on the E5052B power, check the following.

Verification of the Power Supply

Confirm that the power supplied to the E5052B meets the following requirements:

	Requirements
Voltage	90 to 132 VAC or 198 to 264 VAC ^{*1}
Frequency	47 to 63 Hz
Maximum power consumption	500 VA

*1. Switched automatically by the E5052B in conformity to the voltage used.

Verification and Connection of Power Cable

The three-wire power cable attached to the E5052B has one wire serving as a ground. Using this power cable allows the E5052B to be grounded, thereby protecting you against electrical shock from the power outlet.

Step 1. Confirm that the power cable is not damaged.

WARNING NEVER use a power cable showing any sign of damage. Faulty cables can cause electrical shock.



Step 2. Use the supplied cable to connect between the power cable receptacle (Figure 2-5 on page 25) on the rear panel of the E5052B and a three-wire power outlet with the grounding prong firmly connected in the ground slot.

WARNING Use the supplied power cable with grounding wire to securely ground the E5052B.

Figure 2-4 shows the power cable options.

Installation
Power Supply

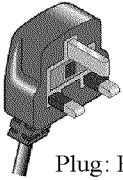
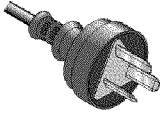
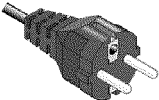
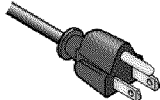
Figure 2-4 Power cable options

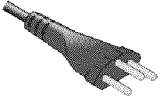
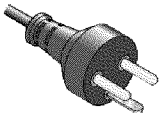
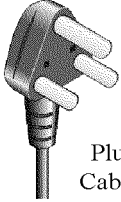
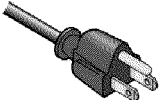
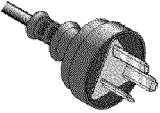
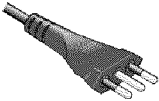
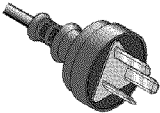
<p>OPTION 900</p>  <p>United Kingdom</p> <p>Plug: BS 1363/A, 250V, 10A Cable: 8120-1351, 8120-8705</p>	<p>OPTION 901</p>  <p>Australia/New Zealand</p> <p>Plug: AS 3112, 250V, 10A Cable: 8120-1369</p>
<p>OPTION 902</p>  <p>Continental Europe</p> <p>Plug: CEE 7 Standard Sheet VII, 250V, 10A Cable: 8120-1689</p>	<p>OPTION 903</p>  <p>U.S./Canada</p> <p>Plug: NEMA 5-15P, 125V, 10A Cable: 8120-1378</p>
<p>OPTION 904</p>  <p>U.S./Canada</p> <p>Plug: NEMA 6-15P, 250V, 6A Cable: 8120-0698</p>	<p>OPTION 906</p>  <p>Switzerland</p> <p>Plug: SEV Type 12, 250V, 10A Cable: 8120-2104</p>
<p>OPTION 912</p>  <p>Denmark</p> <p>Plug: SR 107-2-D, 250V, 10A Cable: 8120-2956</p>	<p>OPTION 917</p>  <p>India/Republic of S. Africa</p> <p>Plug: IEC 83-B1, 250V, 10A Cable: 8120-4211</p>
<p>OPTION 918</p>  <p>Japan</p> <p>Plug: JIS C 8303, 125V, 12A Cable: 8120-4753</p>	<p>OPTION 920</p>  <p>Argentina</p> <p>Plug: Argentine Resolution 63, Annex IV, 250V, 10A Cable: 8120-6870</p>
<p>OPTION 921</p>  <p>Chile</p> <p>Plug: CEI 23-16, 250V, 10A Cable: 8120-6978</p>	<p>OPTION 922</p>  <p>China</p> <p>Plug: GB 1002, 250V, 10A Cable: 8120-8376</p>
<p>NOTE: Each option number includes a 'family' of cords and connectors of various materials and plug body configurations (straight, 90° etc.).</p>	

power_e

Blown fuses

If the fuse appears to have blown during operation, this instrument may be subject to failure and must be repaired. Ship the E5052B to the nearest Agilent Technologies Service Center.

WARNING

Do NOT replace the fuse yourself; doing this may expose you to dangerous electrical shock.

Starting the E5052B



This section describes how to turn on/off the E5052B power and how to cut off the power supply in an emergency.

Turning the Power ON and OFF

Perform the following steps to turn the power ON or OFF.

Turning the Power ON

Step 1. Confirm if the Line Switch on the rear panel is on. The switch should always be turned on.

Step 2. If the standby switch () in the lower-left part of the front panel is in the depressed () position, press it to put it in the popped up position ().

Step 3. Press the standby switch to put it in the depressed position ().



This operation turns ON the power, and the E5052B starts the self-test.

Step 4. Confirm that the self-test indicates normal operation.

Normal operation is confirmed by the self-test if no error message appears.

Turning the Power OFF

Step 1. Use either of the following methods to turn the power OFF.

- Press the standby switch () in the lower-left part of the front panel (now in the pressed down () position) to put it in the popped up () position.
- Click Turn off Computer from Windows Start menu

These operations will start the E5052B shutdown process (required software and hardware processes for turning the power off), and the power will turn OFF after a few seconds.

NOTE

Under normal circumstances, always press the standby switch (), or click Turn off Computer from Windows Start menu, to execute the E5052B shutdown process. **Never cut off the power supply directly by disconnecting the power cable plug from the rear panel of the unit.**

If the power supply is cut off directly by disconnecting the power cable plug from the instrument or the AC outlet, the shutdown process is not carried out and there is a risk of damage to the E5052B's software or hardware.

Figure 2-5 Line switch (Always ON) and power cable receptacle

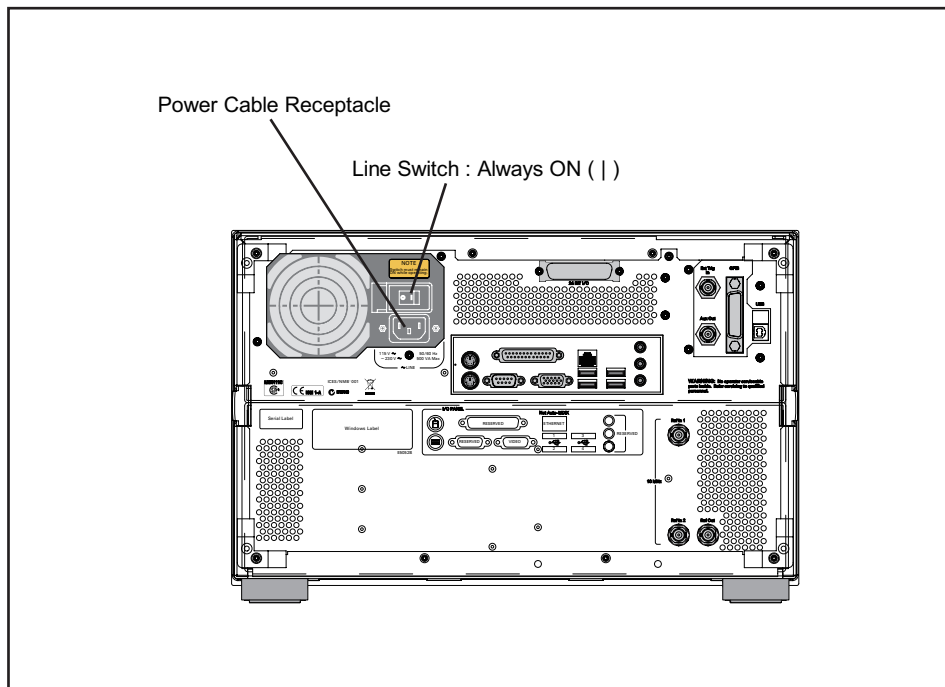

Disconnection from Supply Source

The power supply of the E5052B is cut off by disconnecting the plug of the power cable (on either AC outlet side or E5052B side). When it is necessary to disconnect the power supply in order to avoid shock hazards, etc., pull out the power cable plug from either the AC outlet side or the E5052B side.

NOTE

To allow this operation to be performed smoothly, be sure to follow the guidelines in “Ensuring Adequate Free Space around Analyzer for Immediate Disconnection of Power Cable in Case of Emergency” on page 16.

When turning the power OFF under normal circumstances, always follow the methods described in “Turning the Power OFF” on page 24.

Removing / Mounting Removable Hard Disk

For details of removing / mounting removable hard disk, refer to the following website.

<http://ssa.tm.agilent.com/e5052b/manuals/webhelp/eng/>

Initial Registration of E5052B

When you start up the E5052B at the first time, you need to perform the initial registration of the Windows XP operating system of the E5052B.

NOTE You cannot use the front panel keys during the initial registration of the E5052B therefore connect the mouse and the keyboard before turning on the power.

NOTE If you perform the following procedure incorrectly, a message asking you whether to return to the previous registration screen and perform the registration appears. In this case, follow the instruction to return to the previous registration screen.

Step 1. Turns on the E5052B.

Step 2. The Windows XP Professional Setup wizard appears. Click the **Next >** button (Figure 2-6).

Figure 2-6 Windows XP Professional Setup wizard



e5071cse1073

Installation

Initial Registration of E5052B

Step 3. In the Windows XP Professional Setup dialog box, select the **I accept this agreement** box and click the **Next >** button (Figure 2-7).

Figure 2-7

Windows XP Professional Setup dialog box (1/2)

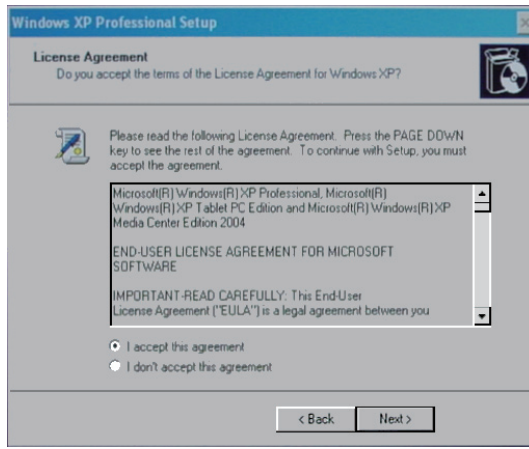

Step 4. In the next dialog box, input **E5052** in the **Name** box. Then, click the **Next>** button (Figure 2-8).

Figure 2-8

Windows XP Professional Setup dialog box (2/2)

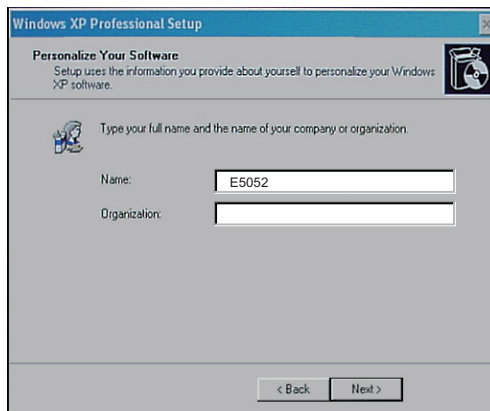

Step 5. After a while, the E5052B restarts automatically. Then, the measurement display appears.

Calibration of the Touch Screen

After E5052B measurement screen appears, you have to calibrate the touch screen. Follow the procedure described below to calibrate the touch screen.

- Step 1. Press **System**.
- Step 2. Press **Service Menu**.
- Step 3. Press **Test Menu**.
- Step 4. Press **Adjust Touch Screen**.

The touch screen calibration screen (Figure 2-9) appears.

Figure 2-9

Touch Panel Calibration Screen

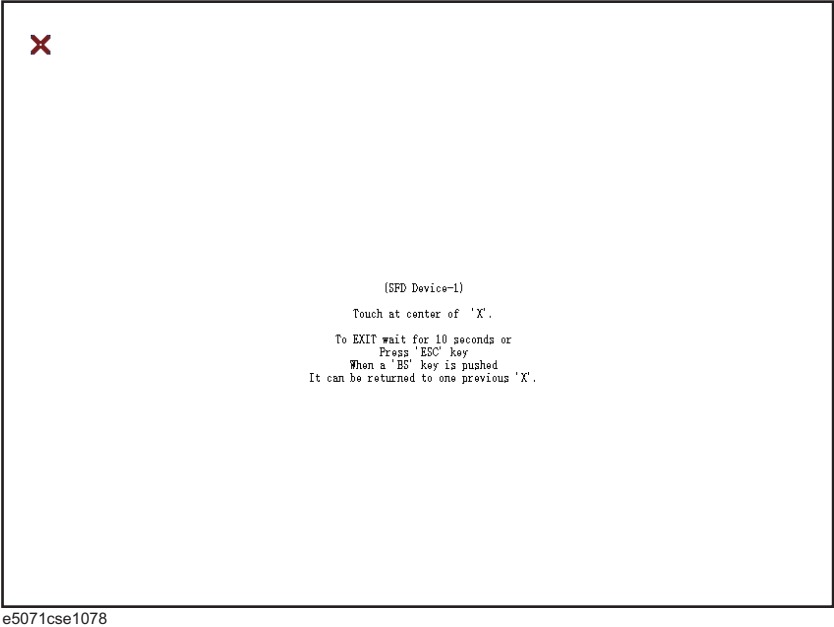

- Step 5. Touch the x mark on the upper left with your finger. The mark x appears also on the upper right, lower left, and lower right. Touch the x marks in that order with your finger. Touching the four locations described above with your finger automatically concludes the touch screen calibration.

NOTE With no operation on the touch screen calibration screen for a preset time, it automatically closes and the previous measurement screen reappears.

Installation
Calibration of the Touch Screen

3 Troubleshooting

This chapter describes the troubleshooting during start up and the procedure of the operating system (OS) recovery when the Windows XP OS has been damaged.

Troubleshooting during Startup

When you encounter the problem during start up, see Table 3-1. System recovery saves most of problems.

Table 3-1

Troubleshooting during startup

Symptom	Solution
Turning on (I) the standby switch does not start up the system.	Confirm that the power cable is properly plugged in. Confirm that the line switch on the rear panel is turned on
The system starts up, but it automatically shuts down immediately.	Execute the system recovery.
The system starts up, but it enters the service mode (The instrument status bar in the lower right part of the screen displays SVC in red).	
The measurement screen appears after startup, but the power on test failed, appearing against a red background in the instrument message/warning area in the lower left part of the screen.	

System Recovery

By executing system recovery, you can return the system of the E5052B (the Windows operating system and the firmware) to the factory state (at the time of purchase*¹).

CAUTION

Strictly follow the steps described below. If you do any operation other than the following steps, the system may not be recovered.

Types of system recoveries

The following 2 types of system recoveries are available.

Factory recovery

Returns the contents of the C drive to the factory state.

User recovery

Returns the contents of the C and F drives to a user-specified state. To use this function, you must prepare for recovery in advance. For information on the preparation, see “Procedure to create the user backup image” on page 37 for information on the execution, see “Procedure to execute the user recovery function” on page 43.

Notes on executing the factory recovery function

Executing the factory recovery function causes the following conditions:

- In addition to the Windows operating system and the firmware, the following settings of the E5052B are returned to the factory state.
 - Network setting
 - GPIB setting
 - Printer setting
- The driver for the supported printer installed after purchase is deleted.
- You need to execute initial registration again.

Files you created using the save function (files in the F drive) are not affected, but we recommend backing them up before executing system recovery for precautionary purposes. For more information on backup, refer to “Backing Up the Data” as described in E5052B Online Help.

*1. If the hard disk failed and has been replaced after purchase, the state when the replacement was performed is recovered.

Procedure to execute the factory recovery

This section describes how to return the contents of the C drive to the factory state.

NOTE You need a keyboard for this operation.

- Step 1.** Shut down the E5052B.
- Step 2.** Disconnect all of the USB device from the USB ports.
- Step 3.** Connect the keyboard to the E5052B.
- Step 4.** Press the standby switch of the E5052B to turn it on.
- Step 5.** When the screen as shown in the figure below appears, press **F11** of the keyboard.

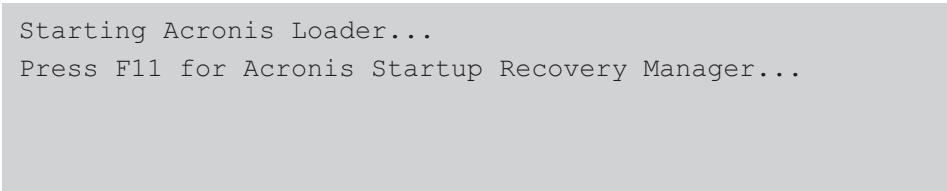

```
Starting Acronis Loader...  
Press F11 for Acronis Startup Recovery Manager...
```

e5071cse1055

CAUTION Press F11 only once. If you press F11 twice or more and a screen which is not mentioned in this manual appears, reboot the instrument and restart the process from the first.

NOTE After several seconds, the next screen appears automatically even if you do not press any key, so do not miss it.

NOTE After Step 5, if the E5052B freezes with the cursor blinks, turn the power off and remove unnecessary USB devices. Then, replace the keyboard with a PS/2 keyboard to execute the process again.

Step 6. Select **Restore**.

Figure 3-1 **Activate Acronis Startup Recovery Manager**

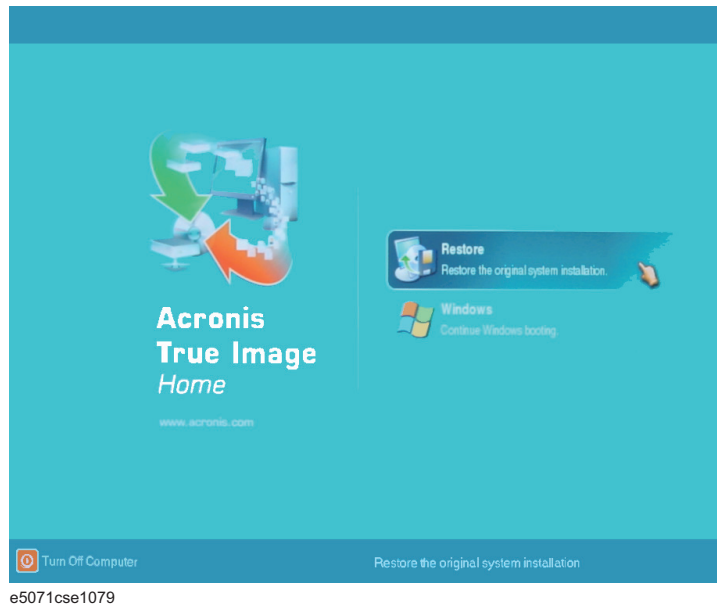

Step 7. A confirmation dialog box is displayed. Push the enter to select **Yes** to start the recovery of the factory backup. The recovery takes a few minutes depending on the amount of data.

Figure 3-2 **Recover Factory Backup**

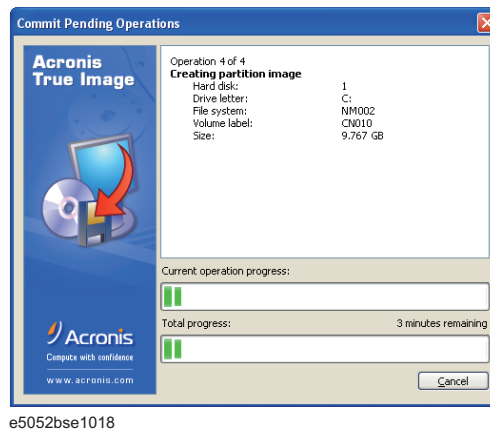

Step 8. When the recovery is finished, push the enter select OK. The E5052B restarts automatically.

Step 9. After restart, the screen for initial registration appears. Execute initial registration. For information on the execution procedure, refer to “Initial Registration of E5052B” on page 21.

Step 10. Execute the calibration of the touch screen. For information on the execution procedure, refer to “Calibration of the Touch Screen” on page 23.

CAUTION

Never turn off the power during the system recovery because doing so may cause serious damage to the E5052B.

Procedure to create the user backup image

This section describes how to create the user backup image. The C and F drives' contents saved in this procedure are recalled when the user recovery function is executed.

- Step 1.** Close the E5052B application by pressing **System** > Service Menu > Administrator Menu > Exit E5052B > OK.
- Step 2.** Close all other applications you currently open.
- Step 3.** From the Windows start menu, select All Programs > Acronis > Acronis True Image.
- Step 4.** Click “No, Thanks” button.

Figure 3-3 Recover User Backup

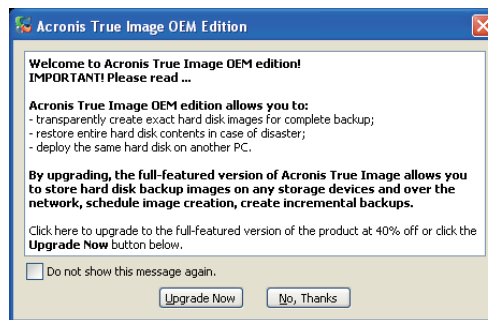

e5071cse1080

- Step 5.** Click **Backup**

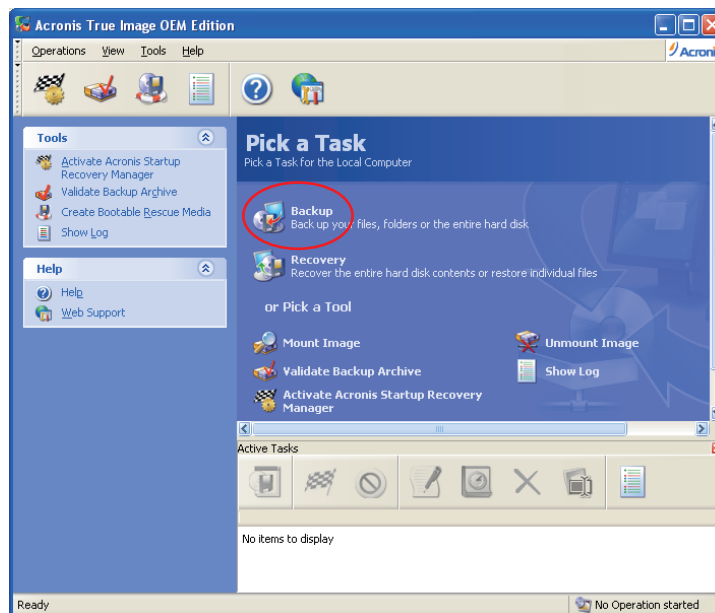

e5071cse1125

Troubleshooting System Recovery

Step 6. Click **Next** button.



e5071cse1126

Step 7. Select “The entire disk contents or individual partition,” then click **Next** button.

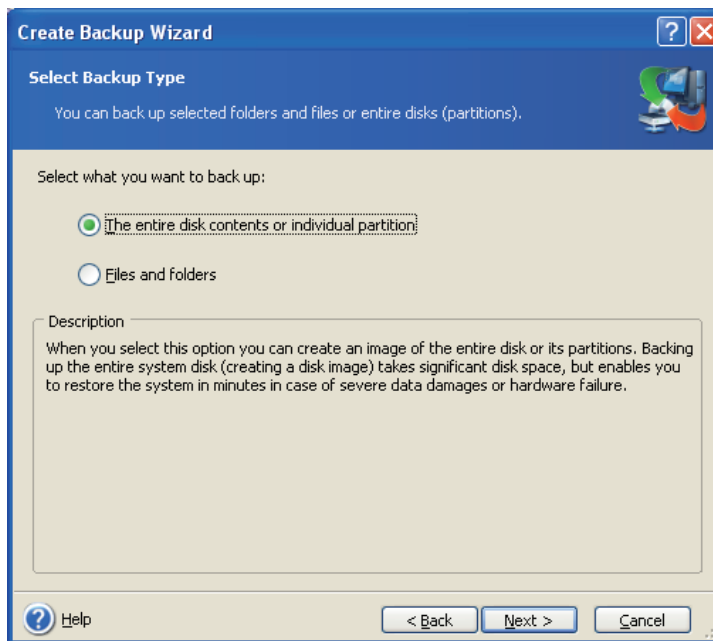

e5071cse1127

Step 8. Select the C drive and F drive.

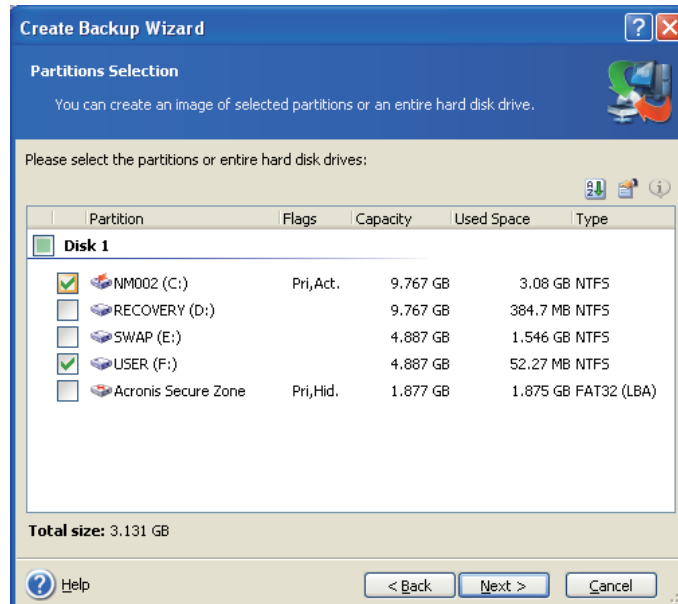

e5052bse1019

Step 9. Select the destination folder and input a file name, then click **Next** button. It is recommended to save the file to a directory which has enough space like the D drive. Also, never save the contents of the drive to the C, E or F drive.

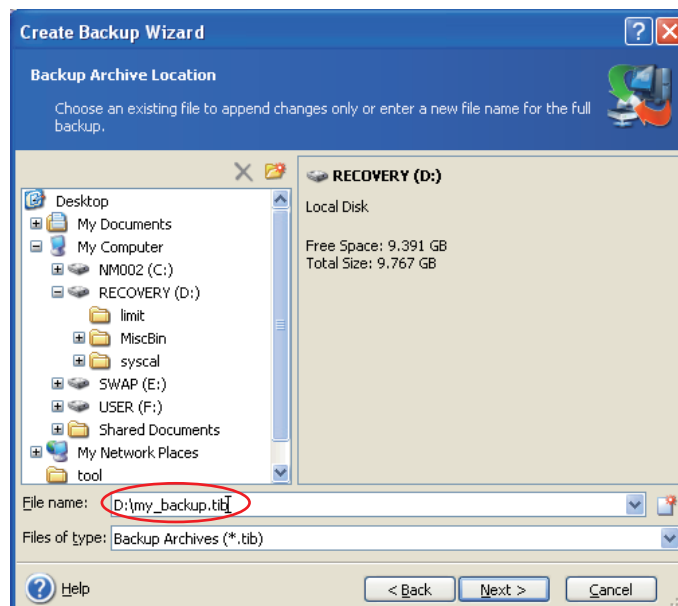

e5052bse1020

Troubleshooting System Recovery

Step 10. Select “Set the options manually” and click **Next** button.

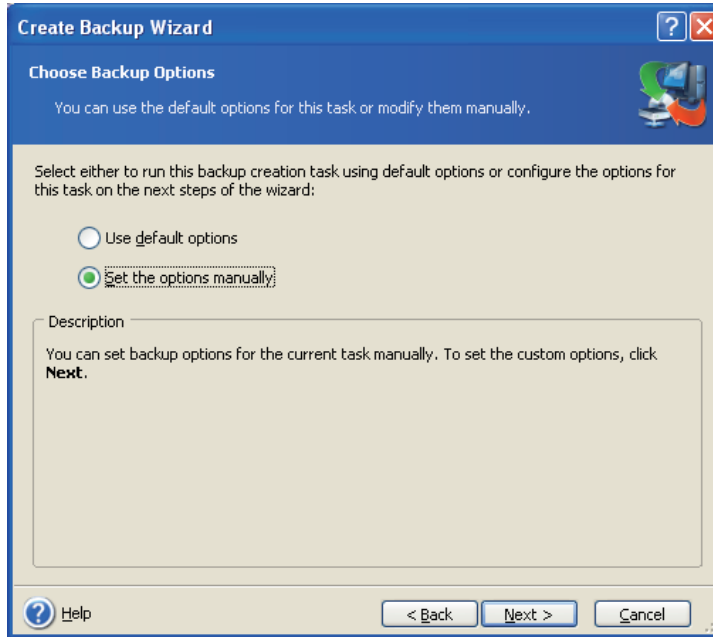

e5071cse1130

Step 11. Select “Backup priority” in the left field and “High” in the right field, then click **Next** button.

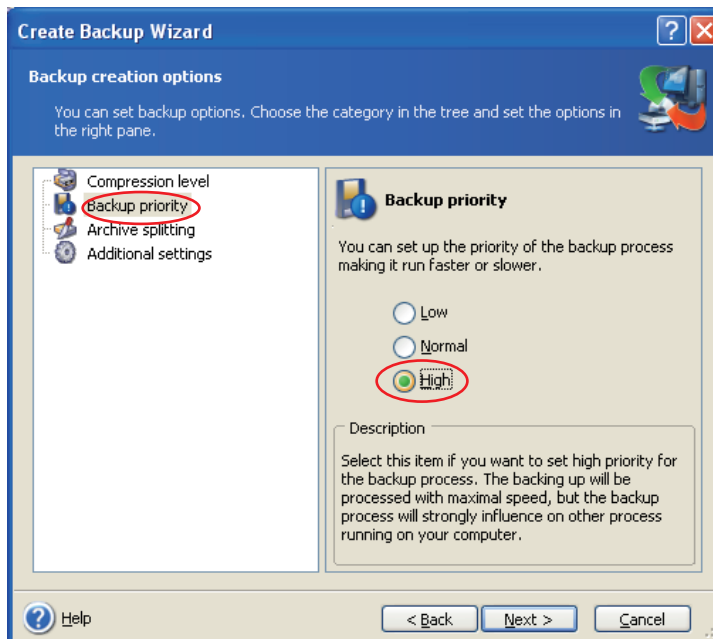

e5071cse1131

Step 12. If necessary, input comments and click **Next** button. The comments can be omitted.

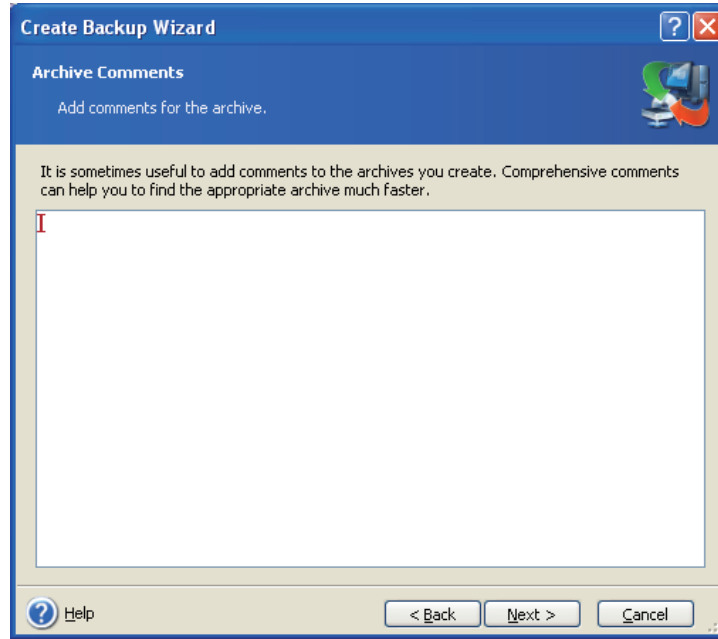

e5071cse1132

Step 13. Click **Proceed** button.

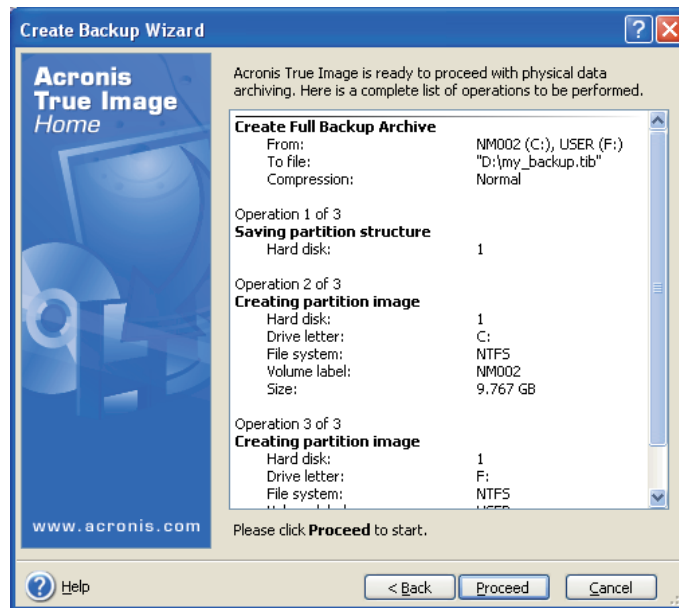

e5052bse1021

Step 14. The following screen appears during backup.

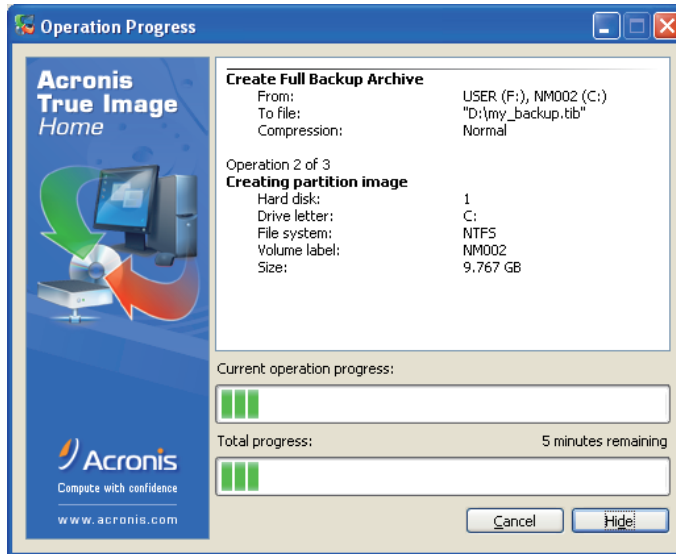

e5052bse1022

Step 15. The following screen appears when the user backup image was created. Click **OK**.

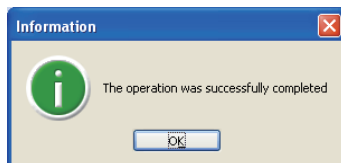

e5052bse1023

CAUTION

Never turn off the power during creating the user backup image because doing so may cause serious damage to the E5052B.

Procedure to execute the user recovery function

Returns the contents of the C and F drives to a user-specified state. To use this function, you must create the user backup image in advance. For more information, see the description “Procedure to create the user backup image” on page 37.

- Step 1.** Close the E5052B application by pressing **System** > Service Menu > Exit.
- Step 2.** Close all other applications you currently open.
- Step 3.** From the Windows start menu, select All Programs > Acronis > Acronis True Image.
- Step 4.** Click “No, Thanks” button.

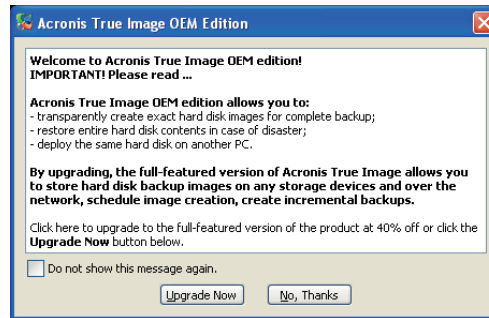

e5071cse1080

- Step 5.** Click **Recovery**.

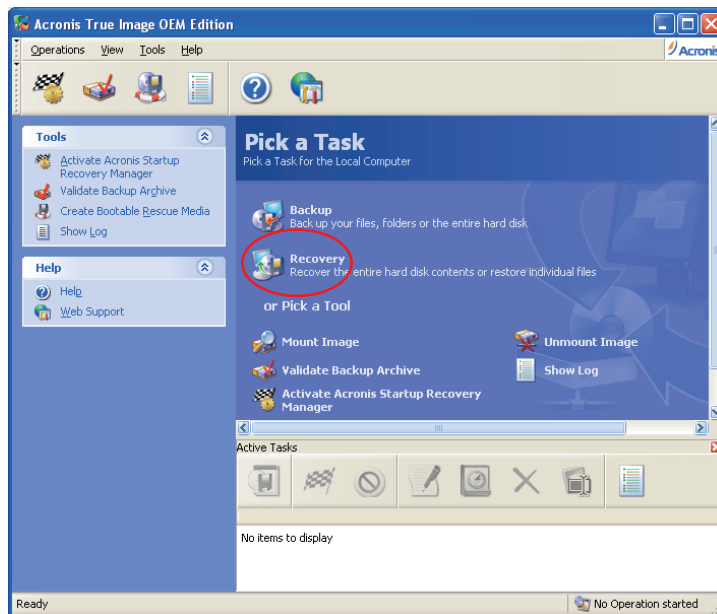

e5071cse1136

Troubleshooting System Recovery

Step 6. Click **Next** button.



e5071cse1137

Step 7. Select the saved backup image file, then click **Next** button.

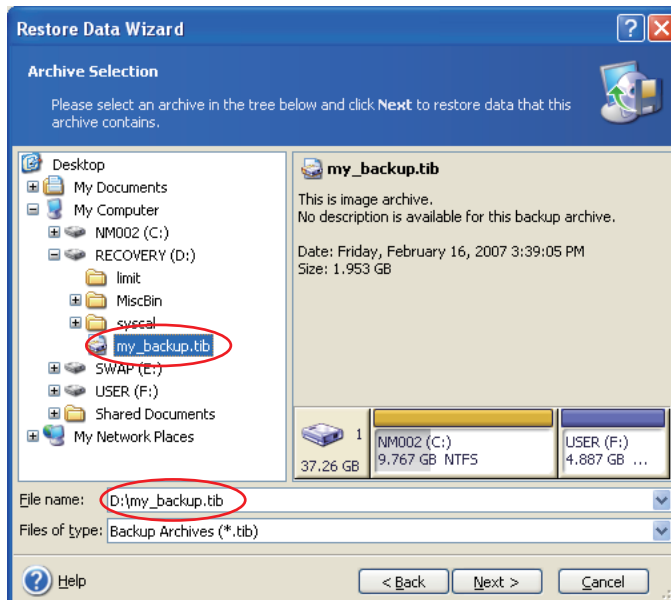

e5052bse1024

Step 8. Select “Restore disks or partitions,” then click **Next** button.

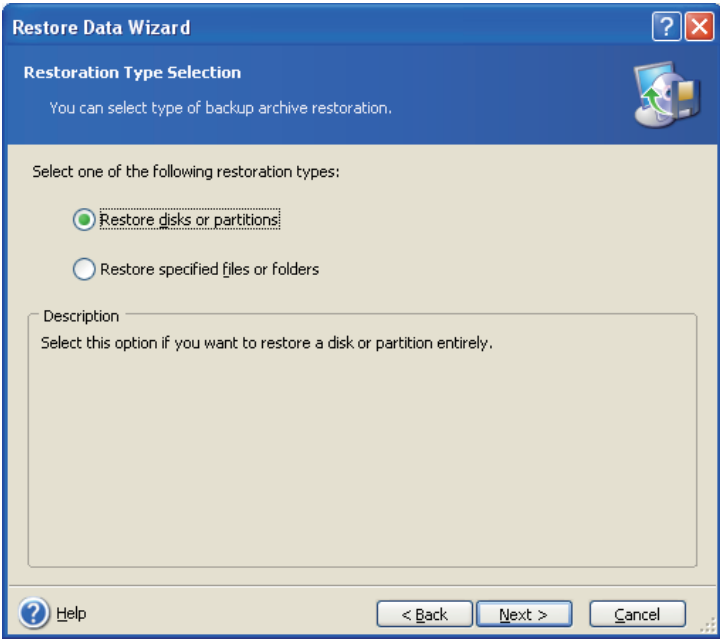

e5071cse1139

Step 9. Select the C drive, then click **Next** button.

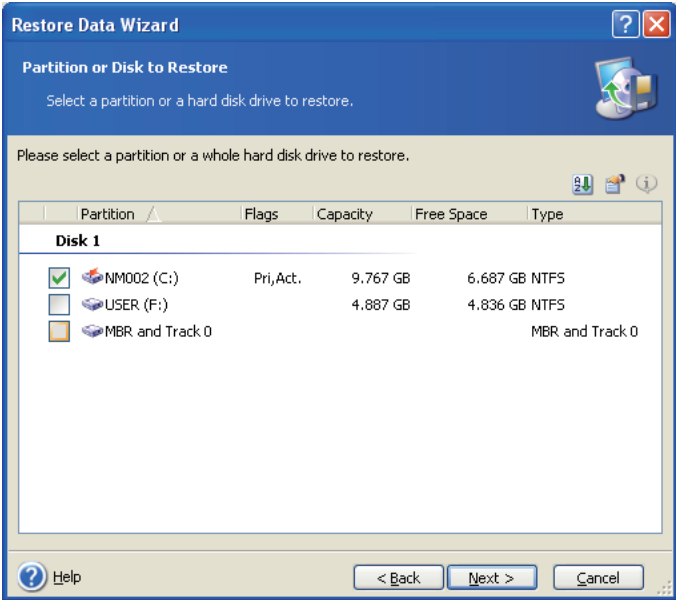

e5052bse1025

3. Troubleshooting

Troubleshooting System Recovery

Step 10. Select the C drive to restore, then click **Next** button.

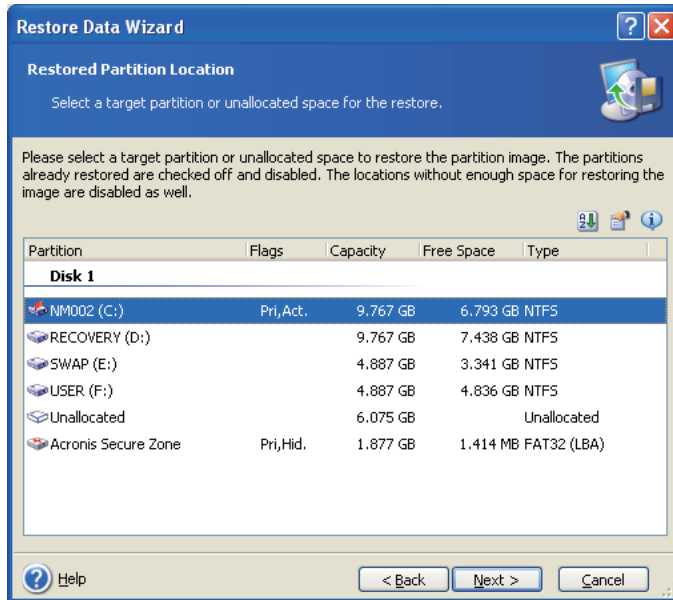

e5052bse1026

Step 11. Select "Active" and click **Next** button.

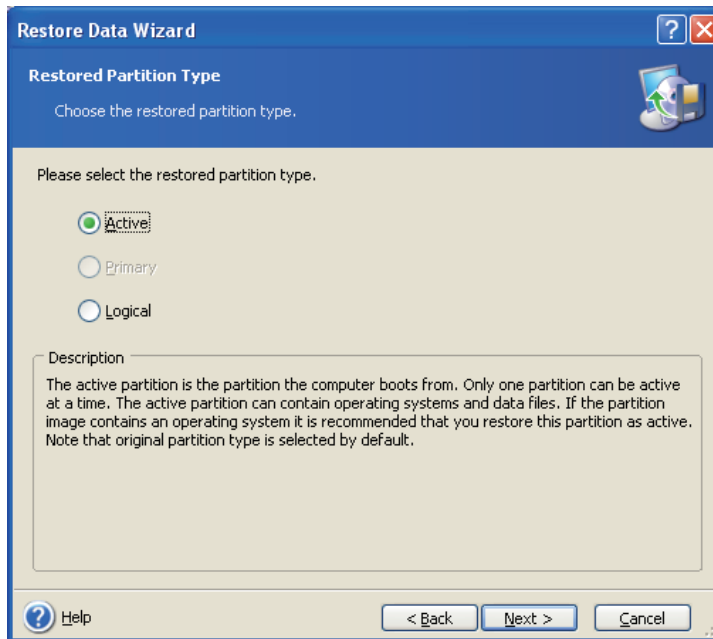

e5071cse1145

Step 12. Click **Next** button.

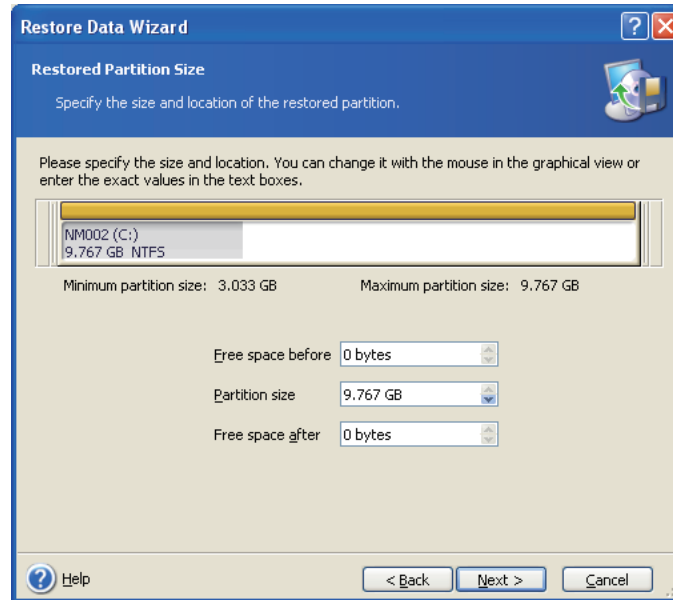

e5052bse1027

Step 13. Select “Yes, I want to assign a logical drive letter to the restored partition.” and click **Next** button.

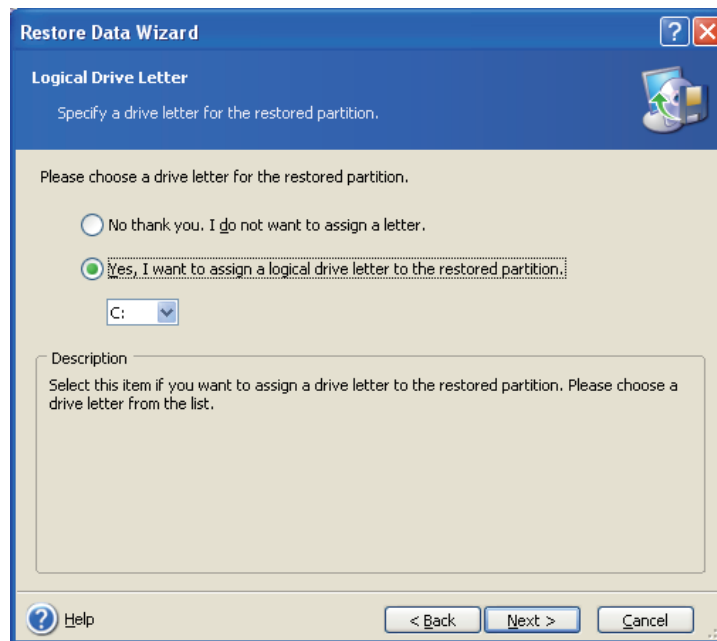

e5071cse1147

Troubleshooting System Recovery

Step 14. Select “Yes, I want to restore another partition or hard disk drive.” then click **Next** button.

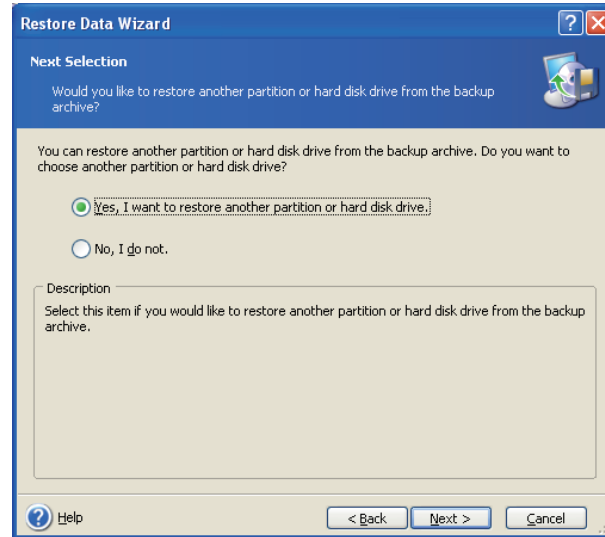

e5052bse1077

Step 15. Select the F drive to restore, then click **Next** button.

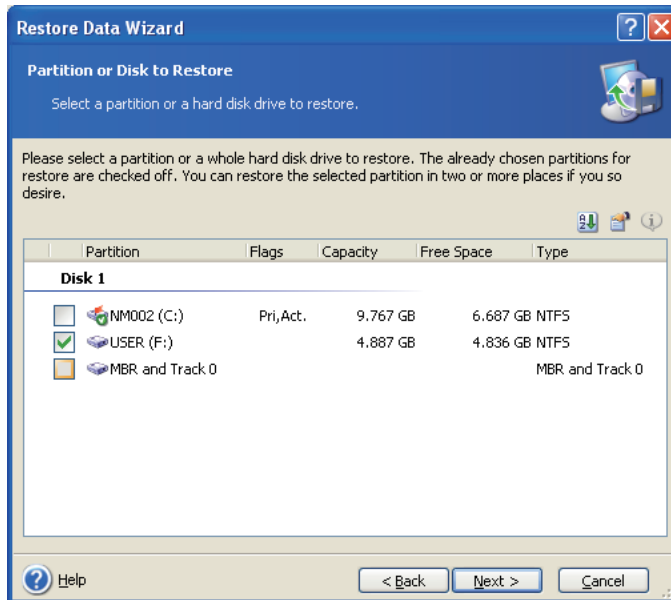

e5052bse1028

Step 16. Select the F drive to restore, then click **Next** button.

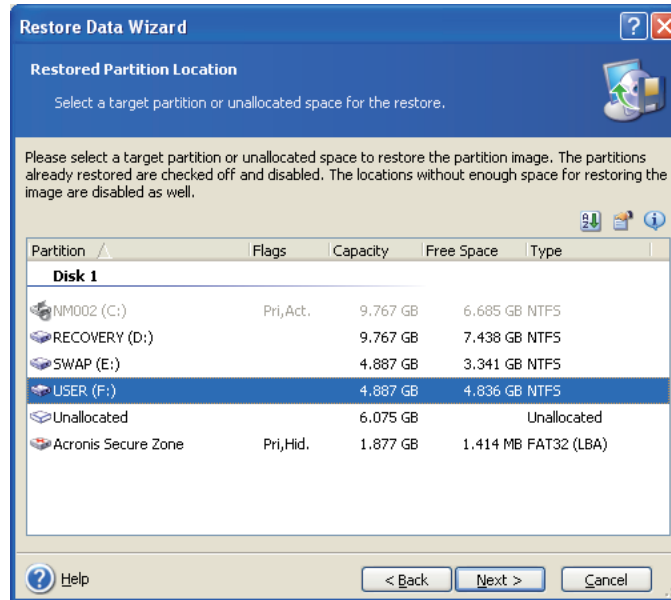

e5052bse1029

Step 17. Select “Logical” and click **Next** button.



e5052bse1078

Troubleshooting System Recovery

Step 18. Click **Next** button.

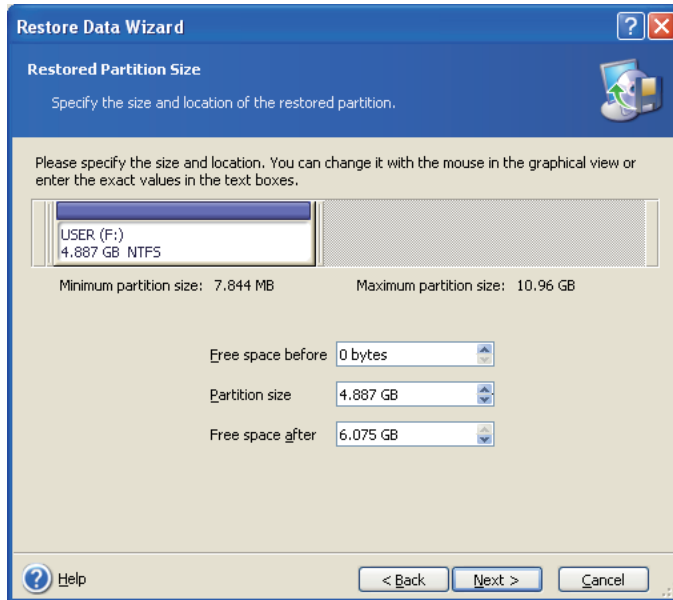

e5052bse1030

Step 19. Select “Yes, I want to assign a logical drive letter to the restored partition,” then click **Next** button.

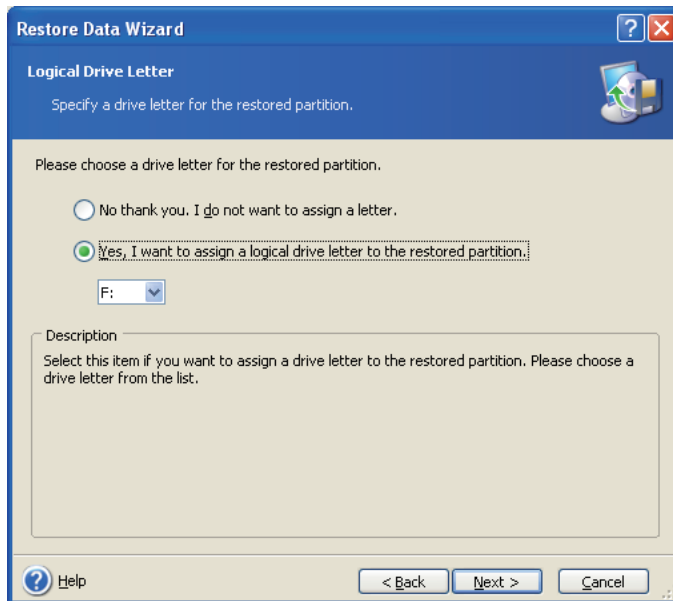

e5052bse1031

Step 20. Select “No, I do not.” and click **Next** button.



e5052bse1079

Step 21. Select “Set the options manually” and click **Next** button.



e5052bse1080

Troubleshooting System Recovery

Step 22. Select “Restoration Priority” in the left field and “High” in the right field, then click **Next** button.



e5052bse1081

Step 23. Click **Proceed** button.

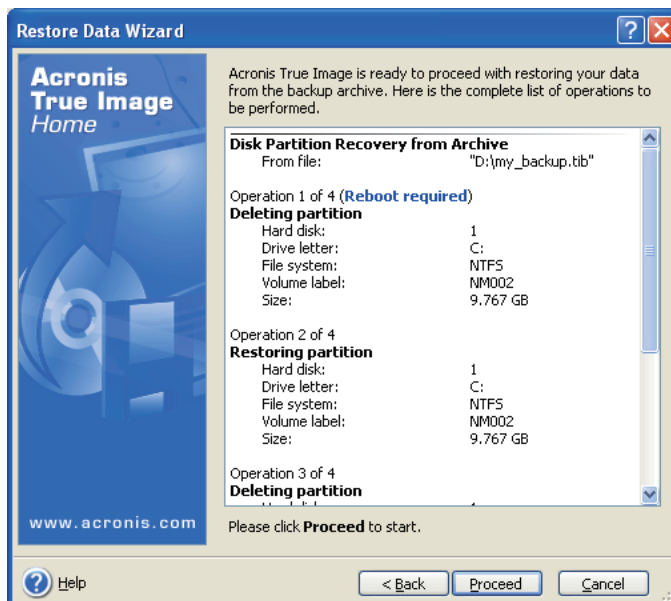

e5052bse1032

Step 24. Click **Reboot** button.

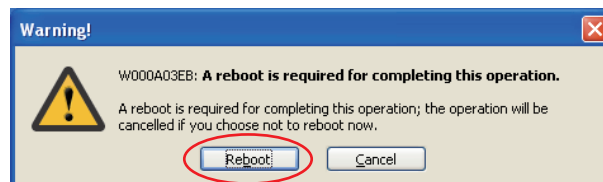

e5052bse1082

CAUTION

Never turn off the power during the recovery of the user backup image because doing so may cause serious damage to the E5052B.

- Step 25.** After boot up, perform “Initial Registration of E5052B” on page 27 and “Calibration of the Touch Screen” on page 29.

A

accessories
items packaged with the E5052B, 13
assistance, 5

C

cable
power cable options, 21
certification, 5

D

Documentation Warranty, 5

E

environmental requirements
operation environment, 14
ventilation space, 15
exclusive remedies, 5

F

front handles
how to install the handle kit, 18

H

handle and rack-mount kit
how to install the rack-mount and handle kit, 19
handle kit
how to install the handle kit, 18
history,
manual printing, 2

I

Initial registration, 27
inspection
checking the shipment, 13

M

manual
contents, 10
manual printing history, 2

P

power
check the power supply, 21
disconnecting device, 25
disconnection from supply source, 25
power cable options, 21
shutdown, 24
verification and connection of power cable, 21

Q

Quick Start Guide
contents, 10

R

rack-mount and handle kit
how to install the rack-mount and handle kit, 19
rack-mount kit
how to install the rack-mount kit, 19
Registration, 27
Removable hard disk, 26

S

safety
symbols, 4
safety summary, 3
shutdown
turning the power OFF, 24
system
installing rack mount flanges, 17
System Recovery
How to Execute, 33

T

Touch Screen
Calibration, 29
typeface conventions, 6

W

Windows XP, 27

REGIONAL SALES AND SUPPORT OFFICES

For more information about Agilent Technologies test and measurement products, applications, services, and for a current sales office listing, visit our web site: <http://www.agilent.com/find/tmdir>. You can also contact one of the following centers and ask for a test and measurement sales representative. 21/01/2004

United States:

Test and Measurement Call Center
(tel) 1 800 452-4844
(fax) 1 888 900-8921

Australia/New Zealand:

(tel) (61 3) 9210-5555 (Australia)
(fax) (61 3) 9210-5899
(tel) (64 4) 939-0636 (New Zealand)
(fax) (64 4) 972-5364

Canada:

Test and Measurement Call Center
(tel) 1 877 894-4414
(fax) 1 888 900-8921

Asia Pacific:

(tel) (65) 6375-8100
(fax) (65) 6836-0252
Email: tm_asia@agilent.com

China:

(tel) 800 810-0189
(fax) 800 820-2816

Europe:

(tel) (31 20) 547-2323
(fax) (31 20) 547-2390

Japan:

Call Center
(tel) 0120 421-345
(tel) (81) 426 56-7832
(fax) (81) 426 56-7840

Korea:

(tel) (82 2) 2004-5004
(fax) (82 2) 2004-5115

Latin America:

(tel) (305) 269-7500
(fax) (305) 269-7599

Taiwan:

(tel) 0800 047 866
(fax) 0800 286 331